

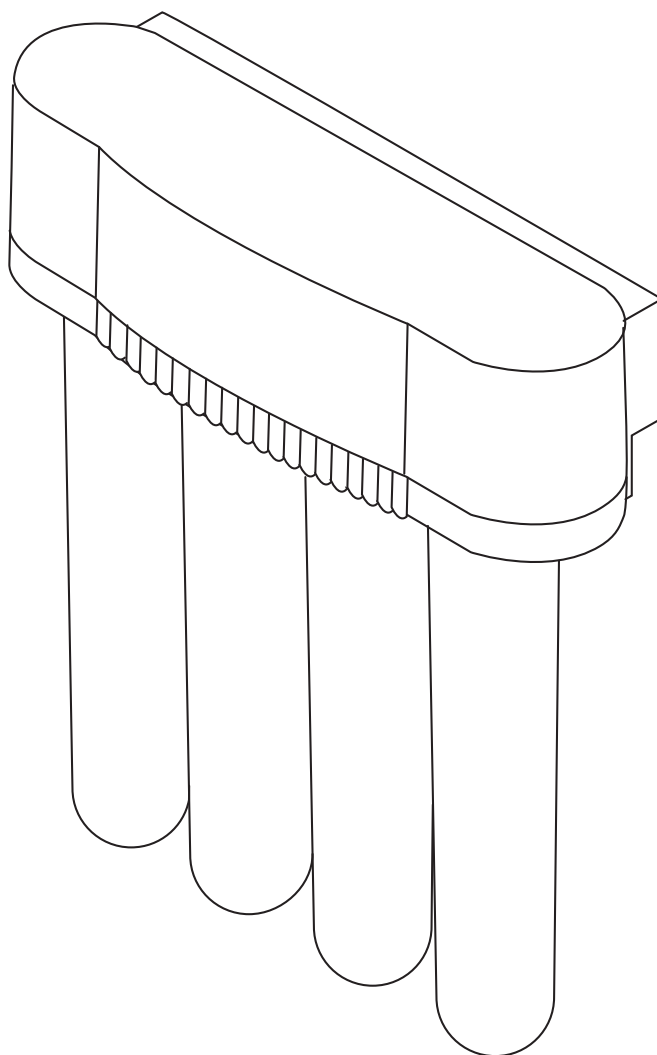

Installation and Operating Instructions For 3MR0401 Reverse Osmosis Drinking Water Filtration System



Installer: Please leave manual with homeowner.



Homeowner: Please retain for operation and future maintenance instructions.

SAFETY INFORMATION

Read, understand and follow all safety information contained in these instructions prior to installation and use of the 3MRO401 Reverse Osmosis Drinking Water Filtration System. Retain these instructions for future reference.

Intended use:

The 3MRO401 Reverse Osmosis Drinking Water Filtration System is intended for use in filtering drinking water in residential locations and has not been evaluated for other uses. The system is typically installed beneath a kitchen sink, and must be installed as specified in the installation instructions by a qualified professional installer.

EXPLANATION OF SIGNAL WORD CONSEQUENCES	
 WARNING	Indicates a potentially hazardous situation, which, if not avoided, could result in death or serious injury and/or property damage.
 CAUTION	Indicates a potentially hazardous situation, which, if not avoided, may result in minor or moderate injury and/or property damage.
CAUTION	Indicates a potentially hazardous situation, which, if not avoided, may result in property damage.

 WARNING
<p>To reduce the risk associated with choking:</p> <ul style="list-style-type: none"> • Do not allow children under 3 years of age to have access to small parts during the installation of this product.
<p>To reduce the risk associated with ingestion of contaminants:</p> <ul style="list-style-type: none"> • Do not use with water that is microbiologically unsafe or of unknown quality without adequate disinfection before or after the system. Systems certified for cyst reduction may be used on disinfected water that may contain filterable cysts. EPA Establishment # 070595-CT-001
<p>To reduce the risk associated with a hazardous voltage due to an installer drilling through existing electric wiring or water pipes in the area of installation:</p> <ul style="list-style-type: none"> • Do not install near electric wiring or piping which may be in the path of a drilling tool when selecting the position to mount the filter bracket.
<p>To reduce the risk of physical injury:</p> <ul style="list-style-type: none"> • All hydro-pneumatic pressurized tanks must have an appropriate pressure relief valve installed. • Shut off inlet water supply and depressurize system as shown in manual prior to filter removal.
<p>To reduce the risk of injury associated with household bleach:</p> <ul style="list-style-type: none"> • Read and follow manufacturer's directions and cautions. • Keep out of the reach of children. • DO NOT intermix with other chemicals.
<p>To reduce the risk associated with ingestion of water contaminated with sanitizer:</p> <ul style="list-style-type: none"> • After installation, sanitizers must be flushed from the system before first use as directed within the installation instructions (dilute bleach solution).

 CAUTION
<p>To reduce the risk of eye injury while drilling countertop for faucet installations:</p> <ul style="list-style-type: none"> • Safety glasses MUST be worn during the sink hole drilling operations.

CAUTION

To reduce the risk associated with property damage due to water leakage:

- **Read and follow** Use Instructions before installation and use of this system.
- Installation and Use **MUST** comply with all state and local plumbing codes.
- **Protect from freezing**, remove filter cartridge when temperatures are expected to drop below 40° F (4.4° C).
- **Do not** install systems in areas where ambient temperatures may go above 110° F (43.3° C).
- **Do not** install on hot water supply lines. The maximum operating water temperature of this filter system is 100°F (37.8°C).
- **Do not** install if water pressure exceeds 100 psi (689 kPa). If your water pressure exceeds 80 psi, you **must** install a pressure limiting valve. Contact a professional qualified installer if you are uncertain how to check your water pressure.
- **Do not** install where water hammer conditions may occur. If water hammer conditions exist you must install a water hammer arrester. Contact a professional qualified installer if you are uncertain how to check for this condition.
- Where a backflow prevention device is installed on a water system, a device for controlling pressure due to thermal expansion must be installed.
- **Do not** use a torch or other high temperature sources near filter system, replacement filters, plastic fittings or plastic plumbing.
- On plastic fittings, never use pipe sealant or pipe dope. Use PTFE thread tape only, pipe dope properties may deteriorate plastic.
- Take care when using pliers or pipe wrenches to tighten plastic fittings, as damage may occur if over tightening occurs.
- **Do not** install in direct sunlight or outdoors.
- **Do not** install near water pipes which will be in path of a drilling tool when selecting the position to mount the bracket.
- Mount filter in such a position as to prevent it from being struck by other items used in the area of installation.
- Ensure that the location and fasteners will support the weight of the system when installed and full of water.
- Ensure all tubing and fittings are secure and free of leaks.
- **Do not** install unit if any fitting collets are missing. Contact 3M if collets are missing from any fittings.
- All hydropneumatic tanks must have an appropriate pressure relief valve installed.
- The disposable replacement filters must be replaced every 12 months, at the rated capacity or sooner if a noticeable reduction in flow rate occurs.
- The RO membrane module must be replaced every 36 months, at the rated capacity or sooner if a noticeable reduction in flow rate occurs.

IMPORTANT NOTES

- **Failure to install or operate your filter system in accordance with these use instructions or any other installation or use instructions accompanying this product may result in product failure and property damage, including water leakage and will void warranty.**

INTRODUCTION



- **Installation requires some household tools and novice plumbing skills. If you replace your own kitchen and bathroom faucets, you can handle this!**
- **Installation may require drilling a hole in your sink top. A variable speed drill and specialized drill bits may be needed. We highly recommend professional installation!**

This manual explains the installation, operation and maintenance of the 3MRO401 Reverse Osmosis Water Filtration System. Please read each section of this manual carefully.

The RO drinking water system is designed to connect permanently to a home's plumbing system. The installation **MUST** conform to your state and local plumbing codes. Advanced plumbing skills are required to complete your installation. Failure to install the system as instructed will **VOID** the warranty.

TABLE OF CONTENTS

I. Installation Instructions

A.	Determine the system location.....	5
B.	Prepare the area for installation	5
C.	Determine faucet mounting location	5
D.	Make the faucet mounting hole.....	5
E.	Mount the faucet.....	6
F.	Prepare the system for installation	6
G.	Install the feed water connection and tubing	7
H.	Prefill and sanitize the storage tank	7
I.	Install the drain connection.....	7
J.	Install the filtration assembly and storage tank.....	8
K.	Make the tube connections	8
L.	Start up the system.....	8
M.	Flush the system and check the operation.....	8
N.	Installation troubleshooting.....	9

II. Operation & Maintenance Instructions

A.	Important water quality assurance requirements	10
B.	Replacing the filters	10
C.	Replacing the RO membrane module	10
D.	Sanitizing the RO system	11
E.	Long term non-use	12

III.	Limited Warranty	12
------	------------------------	----

I. Installation Instructions

A. DETERMINE THE SYSTEM LOCATION

The system should be located under a sink. The exact placement of the various components will vary from installation to installation. You must decide where to install the faucet, tank and filtration assembly by balancing convenience with ease of installation and servicing. (See Fig. 1).

B. PREPARE THE AREA FOR INSTALLATION

Inspect the cold water supply line and determine if any special fittings, in addition to what is included in the kit, are required.

IMPORTANT NOTE:

It is a good idea at this time to check the condition of the undercounter plumbing for any existing or potential leaks. Make sure to perform any necessary repairs prior to the installation of the drinking water system.

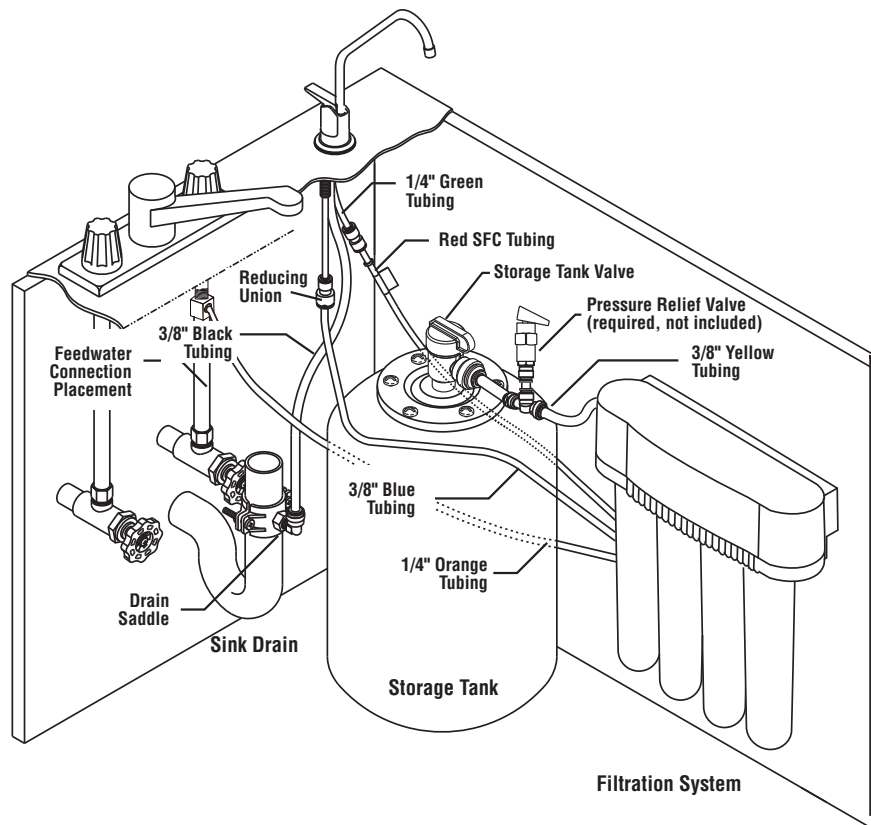

Fig. 1

C. DETERMINE FAUCET MOUNTING LOCATION

If the sink already has a hole provided that can accommodate the RO faucet, then no drilling is required. Additionally, a sprayer may be disconnected to provide a suitable mounting hole for the RO faucet. A pipe cap or plug will be required to seal the connection.

If drilling is required we strongly recommend you contact a professional installer. The faucet should be positioned so that it empties into the sink and the spout swivels freely for convenience.

Before drilling the hole, always check underneath the sink to ensure that nothing will interfere with mounting the faucet such as reinforcing ribs, support brackets or the cabinet construction.

If drilling a hole in your sink is required, the professional installer should follow the instructions below.

D. MAKE THE FAUCET MOUNTING HOLE

CAUTION

To reduce the risk of eye injury while drilling countertop for faucet installations:

- Safety glasses **MUST** be worn during the sink hole drilling operations.

IMPORTANT NOTES

- The drinking water system faucet should be located on a flat surface, conveniently located near the sink, so that it empties into the sink. Most sinks have pre-drilled holes designated for sprayers, soap dispensers, and other accessories. If your sink does not have an extra hole, **we highly recommend professional installation.**
- Porcelain, enamel, and ceramic sinks require special procedures for drilling holes. **Professional installation is highly recommended.**

Drilling 7/8" diameter hole through countertop or stainless steel sink:

1. Locate area to be drilled. Mark center of hole with center punch.
2. Drill hole with 7/8" drill bit suitable for countertop materials or cast iron/stainless steel.
3. With grinding wheel or file, smooth out any rough edges.

Drilling hole through Porcelain/Enamel/Ceramic Sinks
If you are reading this section, professional installation is highly recommended.

Recommended Tools:

- Variable Speed Drill
- Porcelain Cutter Tool Set (7/8" Size)
- Plumber's Putty

Note: It is important to understand this procedure.

1. The glassy layer of porcelain/enamel/ceramic must be scored through to the metal base, creating a disk.
2. This disk must be removed while protecting the surrounding decorative coating against chipping or fracturing.
3. The base metal must be drilled through to complete the hole.

Procedure:

1. Mark center for 7/8" hole.
2. Form a dam of shallow putty around hole location and fill with enough water to lubricate carbide drill bit.
3. Carefully drill pilot hole through porcelain/enamel/ceramic and base metal using a carbide pilot drill bit. Always operate drill with light pressure at slow speed (300 - 400 rpm).
4. Drill porcelain/enamel/ceramic using special 7/8" cutting tool, making certain a complete ring has been cut through to the sink's metal base.
5. Change to metal cutting drill bit and drill out the center of the ring, making sure not to contact other rim of decorative coating. Cut through metal sink base.

E. MOUNT THE FAUCET

Undercounter installations require a faucet with a built-in air gap such as the one included with the system.

Undercounter Installation With An Air Gap Faucet (Air Gap is provided by hole 1" above faucet base):

- 1) Familiarize yourself with all of the components shown in the air gap faucet diagram. (See Fig. 2)
- 2) The rubber washer may be replaced with a bead of plumber's putty for a neater appearance. Remove 3/8" tubing in front of the black faucet handle and discard. Push faucet spout into where the 3/8" tubing was just removed.
- 3) Slide the chrome base plate and rubber washer up the threaded base of faucet.
- 4) Connect the 1/4" green tubing supplied in the installation kit to the smaller barb on the air gap faucet. Push it on firmly until it seats.
- 5) Connect the supplied 3/8" black tubing to the larger barb on the air gap faucet. Push it on firmly until it seats.
- 6) From above the sink countertop, feed the air gap tubing and the threaded nipple through the faucet mounting hole and position the faucet spout over the sink.
- 7) From below the sink/countertop, install the white spacer (open side toward the air gap tubing), flat washer, lock washer and hex nut onto the threaded nipple and tighten it by hand.
- 8) Back off on the hex nut just enough to slide the slotted washer (open side toward the air gap tubes) between the white spacer and the underside of the sink/countertop.
- 9) After rechecking the faucet orientation, tighten the hex nut with a 9/16" wrench until the faucet feels secure.
- 10) From above the sink, make any minor orientation corrections by turning

the faucet on its flats with a padded adjustable wrench. Use care not to mar the finish.

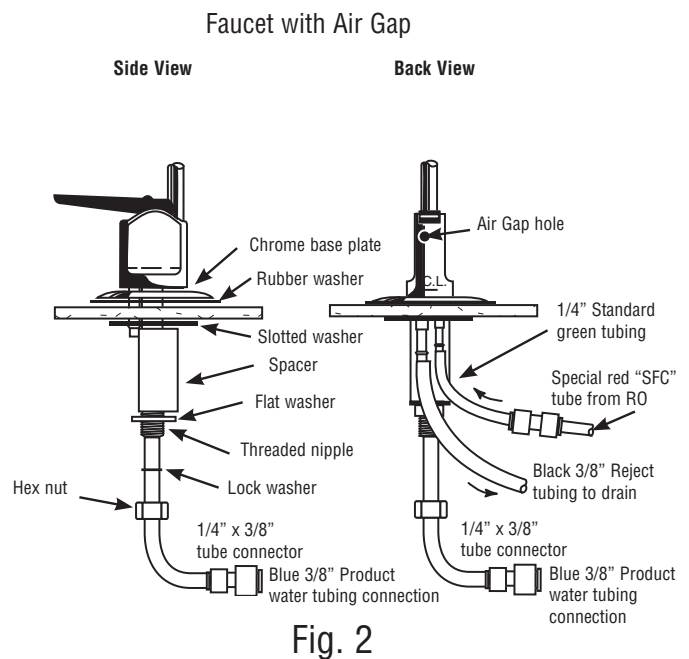

Fig. 2

F. PREPARE THE SYSTEM FOR INSTALLATION

Check to see that the air charge in the empty tank is approximately 7 psi (48 kPa). **Note:** Check the storage tank air pre-charge. Adjust it if necessary. To help keep the membrane as clean as possible, the RO membrane cartridge has been shipped separately in a sealed plastic bag.

G. INSTALL THE FEED WATER CONNECTION AND TUBING

- 1) Open faucet and turn off cold water supply to relieve pressure.
- 2) Locate the cold water stem on the underside of the faucet fixture. Unscrew the cold water feed tube from the faucet stem. Locate the Faucet Adapter that came with your drinking water system. Insert the black gasket into the threaded adapter and tighten onto the Faucet Cold Water Stem under the sink, making sure that 1/4" side connection is accessible and not facing the wall. Make sure not to overtighten.
- 3) Take the Cold Water Feed Tube and attach to the Faucet Adapter, making sure not to over tighten.
- 4) Locate the 1/4" Orange Tubing and insert into the 1/4" outlet of Faucet Adapter. See Figure 3 and "Using Push-in Fittings" below.
- 5) Leave cold water supply off.

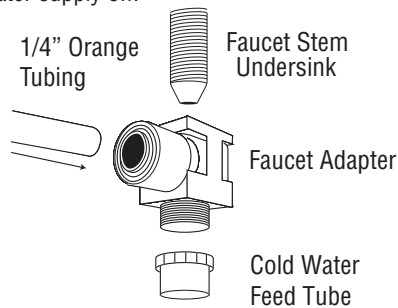
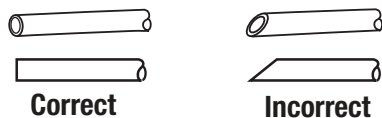

Fig. 3

Cut Tubing Straight



"Using Push-In Fittings"

To Attach Tubing
Push tubing in as far as it will go. Tubing must be inserted past o-ring and hit backstop. Pull tube to ensure it is secured.

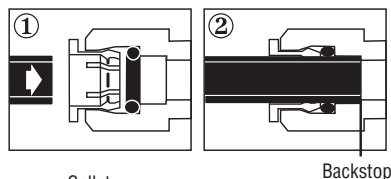

To Release Tubing
Push in grey collet to release tubing. With collet held, pull tubing straight out.

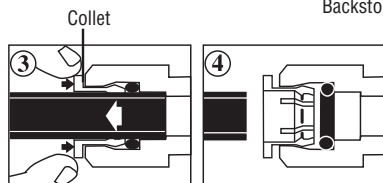

CAUTION

To reduce the risk associated with property damage due to water leakage:
• Ensure all tubing and fittings are secure and free of leaks.

H. PREFILL AND SANITIZE THE STORAGE TANK

Prefilling the storage tank is always recommended so that there is pressure to check for leaks as well as sufficient water to flush the carbon block post-filter. The RO Drinking Water System substitutes the granules with a half teaspoon of common unscented household bleach. (Refer to page 2 for additional information.) It is important to use a sanitizer when prefilling the tank so the solution can sanitize the tubing, fittings, and the faucet at start up.

- 1) Remove protective cover from storage tank and discard. Using an eye dropper, dispense 2 drops of ordinary household bleach into the end of the tank. Apply PTFE tape (not included) to threaded tank connection and install tank valve onto connection. **Do not over tighten.** Open the tank valve so that the tank valve handle is parallel to the valve body.
- 2) Connect one end of the 3/8" yellow tubing into quick connect tank valve. Connect the other end of the 3/8" yellow tubing to the 3/8" x 1/4" union connector included in the tank sanitization kit.
- 3) Connect the free end of the 1/4" orange feedwater tubing to the other end of the 3/8" x 1/4" union connector.
- 4) Open the cold water supply (making sure the tank valve is still open) and allow the tank to fill (about 3 minutes).
- 5) Close the cold water supply and the tank valve. Disconnect the orange and yellow tube from the union connector, setting the tank aside while proceeding with the rest of the installation (the sanitizing solution should be kept in the tank for at least 15 minutes). Refer to the "Using Push-In Fittings" section.

NOTE: If you encounter difficulty in removing the tubing from the 3/8" x 1/4" union connector, make sure the tank valve is closed and cut the yellow tubing approximately 1" away from the tank valve fitting to relieve the pressure. Remove the 1" piece from the tank fitting.

IMPORTANT: After the installation is complete, it is recommended that the 3/8" x 1/4" union connector be saved for future use in tank sanitization.

I. INSTALL THE DRAIN CONNECTION

IMPORTANT:

Before starting this procedure, inspect the condition of the drain piping, especially in older homes where the traps and tailpieces can be deceptively thin and frail. If they are in poor condition, replace prior to installing the drain connection.

IMPORTANT: Some local plumbing codes may prohibit the use of saddle-type drain connections.

Undercounter Installation:

The drain saddle assembly is designed to fit around a standard 1-1/2" OD drain pipe. For smaller (lavatory type) or larger (ABS pipe)

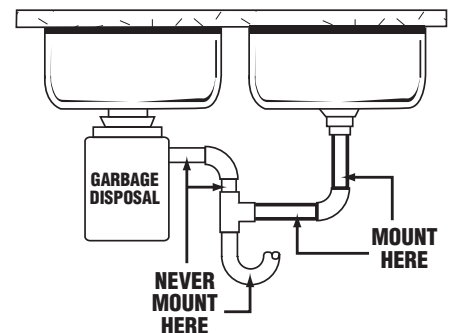

Fig. 4

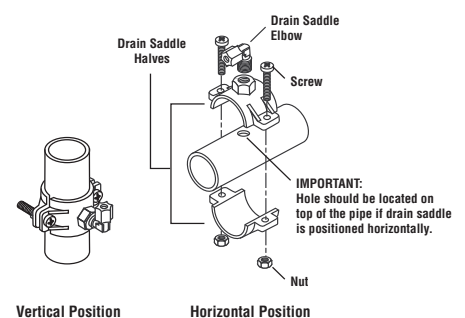

Fig. 5

drains, consult your professional installer for special drain saddles.

The drain saddle should always be installed above (before) the trap and on the vertical or horizontal tailpiece. Never install the drain saddle close to the outlet of a garbage disposal because plugging of the RO drain line may occur. (See Fig. 4)

- 1) Remove backing on foam seal and place over hole on threaded half of the drain saddle. Place drain saddle at the selected location and mark the pipe through the threaded opening.
- 2) Drill a 1/4" hole at the marked location through one side of the drain tailpiece.
- 3) Position both halves of the drain saddle on the drain pipe so that the threaded opening is lined up with the hole in the drain pipe.
- 4) Use the screws and nuts to clamp the drain saddle onto the drain pipe. Make sure that there is equal space between saddle halves on each side. Do not overtighten (See Fig. 5).
- 5) Screw in elbow and orient toward the RO faucet.

J. INSTALL THE FILTRATION ASSEMBLY AND STORAGE TANK

Undercounter Installation:

The filtration assembly is usually mounted to the right or the left side wall inside of the sink cabinet, taking into consideration the space available and the tank location. Generally, the storage tank is placed in the rear of the sink cabinet while the filtration assembly is positioned toward the front for replacement filter accessibility.

Install screws and washers halfway, so you can easily slip the bracket to wall before firmly setting screws. **NOTE:** If you are mounting onto sheetrock or drywall, use anchors or screws (not included).

NOTE: It is essential that the filters be installed in the correct location. Use the icon coded labels to match the replacement filters with their corresponding filter heads.

STEP 1: Cut open the sealed plastic bag and remove the RO membrane module.

STEP 2: Remove the white plug from the fitting at the bottom of the module by pushing in the small white collet and pulling out the plug simultaneously. See "Using Push-in Fittings" on previous page

STEP 3: Remove the sanitary protective cap from the top of the module.

STEP 4: Connect the red SFC reject tubing by inserting it into the fitting as far as it will go, located at the bottom of the RO membrane module. Line up the module ears (See Fig 7), insert the module and push it into the head until it is fully seated. Twist the module 1/4 turn to the right to lock it into place. The final orientation should be such that the module fitting is located towards the rear.

STEP 5: Install remaining replacement filters into their respective filter heads using the icon coded labels, matching the replacement filters with their corresponding filter heads (See Fig 9).

To mount the filtration assembly, elevate it at least 2" (5 cm) off of the cabinet floor and, while keeping it level, mark the location of the mounting holes on the cabinet side wall. Make small pilot holes with an awl or a drill and screw in the two mounting screws; leaving just enough protruding to allow the bracket mounting slots to slide over them.

NOTE: If the cabinet side walls are not of solid construction, the filtration assembly can be set on the cabinet floor and held against the side wall with the mounting screws. However, the filtration assembly will then need to be lifted from the mounting screws in order to remove the replacement filters.

The storage tank may be oriented either vertically or horizontally. It is generally placed to the rear of the cabinet but can be set in the front center (between the sink basins) for ease of access if space permits.

K. MAKE THE TUBING CONNECTIONS

With all of the components in place, the tubing connections can be made. When routing the tubing between the components, several guidelines should be observed.

- Tubing runs should generally follow the contour of the cabinet rather than interfere with the cabinet storage area.
- Strive for a neat and orderly tubing "flow" by using fasteners (e.g. insulated staples) to secure the tubing.
- Arrange the tubing so that there are no sharp bends. Leave some "play" in the tubing for ease of servicing, then cut the tubing to the desired length.
- Try to keep the tubing from the filtration assembly to the tank and faucet as short as practical for good flow.

Undercounter Installation:

The filtration system will use 1/4" orange, 1/4" green, 3/8" blue, 3/8" black and 3/8" yellow tubing supplied with the system.

- 1) The 1/4" orange tubing should have already been connected to the feedwater connection under Section G. Insert the other end into the "Feed" connection labeled on the filtration system (right side).
- 2) Attach the 1/4" x 3/8" union to 1/4" blue tubing on faucet.
- 3) Insert one end of the 3/8" blue tubing into the "Faucet" connection labeled on the filtration system (left side), and the other end into the 1/4" x 3/8" union per Step 2.
- 4) Connect the 3/8" black tubing from the air gap faucet to the drain saddle so that it slopes continuously downward without any loops or low spots. Cut the tubing to the proper length and connect it to the drain elbow.
- 5) Insert one end of the 3/8" yellow tubing into the "Tank" connection labeled on the filtration system, and the other end into the tank valve.
- 6) Route the special red SFC tubing with 1/4" union connector from the RO membrane module to the 1/4" green tubing connected to the faucet. **Do not cut this special SFC tubing.** It's length is important to maintain proper efficiency and performance.

L. START UP THE SYSTEM

- 1) Double check to see that all of the connections are secure.
- 2) Open the cold water feed valve and check the system for leaks. If any leaks are detected, close the valve and correct the problem before proceeding. **NOTE:** If a leak occurs at a "Push In" plastic fitting, then refer to page 7, "Using Push-In Fittings".
- 3) Lift the faucet handle and open the storage tank valve until a steady stream of water flows. Close the faucet, wait at least five (5) minutes and carefully check for leaks. Correct them as necessary.

M. FLUSH THE SYSTEM AND CHECK OPERATION

- 1) With the tank valve closed (the tank should still contain the sanitizing solution at this point), open the faucet (set the faucet handle in the "up" position) and feedwater valve. Water should begin to drip from the faucet within several minutes. Continue to flush the system for 24 hours. Water will steadily drip from the faucet at the time. During this procedure, the tank is being intentionally bypassed in order to thoroughly sanitize the tank and also flush the membrane of any sanitizers.
- 2) After flushing for 24 hours, shut off the faucet. Open the tank valve, lift the faucet handle again and allow the tank to completely empty. When the water begins to drip steadily from the faucet the tank should be empty.
- 3) Close the faucet and reinspect the system for leaks. Allow the tank to fill completely (it will take approximately 4 hours), then drain the tank again. The water should be discarded because it may contain small amounts of sanitizer or sanitizing solution.
- 4) The system should be ready to use as soon as the tank refills. If any objectionable taste is noticed after the second tankful is drained, drain the tank the following day.

N. INSTALLATION TROUBLESHOOTING

Problem: Leak at the drain saddle.

Possible Cause: Drain saddle not clamped tightly enough.

Solution: Tighten the drain saddle screws evenly and firmly.

Problem: Leak at the fittings threaded connection.

Possible Cause: Fitting is improperly taped or not tightened sufficiently.

Solution: Retape the threaded portion with PTFE tape and thread it in firmly. Do not over tighten.

Problem: Leak at the fittings push-in connection.

Possible Cause: Tubing is damaged if there is a tubing misassembly.

Solution: Remove the tubing. Squarely cut off 1/4 inch from the end of the tubing using a sharp razor knife and reinsert it into the fitting. Make sure that the tubing is pushed in completely until it seats. Refer to "Using Push-In Fittings" Section on page 7.

Problem: Leak at the replacement filter head.

Possible Cause: Damaged or misaligned O-ring.

Solution: Close the cold water feed valve and the storage tank valve. Lift up on the faucet handle and drain the system a minimum of five (5) minutes. Remove the replacement filter where leak is found. Ensure both o-rings are present on the replacement filter and are seated into grooves; moisten o-rings with water. DO NOT use any petroleum products to lubricate the o-rings.

Problem: The faucet leaks from the spout with the handle down.

Possible Cause: An obstructed or damaged valve seat in the faucet mechanism.

Solution: Call Customer Care team at 855-3M-WATER (855-369-2837) for assistance in attempt to repair.

Problem: No steady drip from the open faucet after the tank is drained.

Possible Causes:

- The cold water feed valve is not open.
- A leak from any product water fitting connection.
- Air is still trapped in the system.

Solutions:

- Open the cold water feed valve completely.
- Correct the fitting leak as outlined above.
- Wait for the air to be purged from the system.

Problem: Water leaks from air gap module opening.

Possible Causes:

- The drain line is blocked or the drain hole is not drilled through completely.
- The drain line has a loop in it.
- Air is locked in the air gap outlet.
- There is excessive RO reject flow.

Solutions:

- Check to see that the drain line is clear of any obstruction and remove the drain saddle fitting to verify that the hole is drilled through completely.
- Shorten tubing so that it is as vertical as possible.
- Blow air into the air gap outlet using a short length of tubing.
- Disconnect the red SFC reject tubing from the faucet air gap inlet tubing and check the reject flow rate. It should be less than 5.9 ounces/min. If it is greater than 5.9 ounces/min., replace the red SFC reject tubing with the new one of proper length.

Problem: Too little or no reject flow.

Possible Causes:

- Red SFC reject tubing is plugged or damaged.
- The cold water feed valve is not open.

Solutions:

- Replace the SFC reject tubing with one of proper length.
- Open the cold water feed valve completely.

Problem: Chlorine or other unpleasant taste/odor is evident after the initial tank filling.

Possible Cause: Residual sanitizer is still in the water.

Solution: Drain and fill the storage tank several times if necessary.

Problem: Noise in the drain (gurgling or dribbling sound).

Possible Cause: The reject water is dripping into the standing water in the drain trap.

Solutions:

- Make sure that the 3/8" black drain tubing from the faucet air gap module slopes continuously downward to the drain saddle without any loops or low spots.
- Angle the drain piping so that the reject water runs down the side of the drain pipe.
- Change the location of the drain saddle to the horizontal drain pipe or any alternate vertical drain pipe which is farther from the trap. Properly plug the original hole. **Caution:** Make sure the drain saddle is always installed above (before) the trap.
- Drill larger hole in drain pipe.

Problem: Little or no water available.

Possible Cause:

- Tank has not had time to fill.
- Tank has little or no air charge.
- RO membrane module output significantly below normal.

Solutions:

- Wait. The tank will take approximately 4 hours to fill.
- An empty tank with the ball valve open to atmosphere, should have a 7-8 psi air charge.
- Contact our Customer Care Team at 855-3M-WATER (855-369-2837) for instructions.

II. Operation & Maintenance Instructions

Failure to install, operate or maintain your filter system in accordance with these use instructions or any other installation or use instructions accompanying this product may result in product failure and property damage, including water leakage and will void warranty.

A. IMPORTANT WATER QUALITY ASSURANCE REQUIREMENTS

Reverse Osmosis drinking water filtration systems contain treatment components that are critical for the effective reduction of Total Dissolved Solids (TDS) as well as some inorganic chemical contaminants. It is strongly recommended that the user test the water periodically (every six (6) months minimum) to verify that the system is performing satisfactorily. Routine maintenance is necessary in the form of sediment, granulated carbon filter and membrane module, based on the following guidelines:

- Sediment Replacement Filters, Granulated Carbon Replacement Filters & Carbon Block Replacement Post-Filters: Change every twelve (12) months, at the rated capacity or sooner if a noticeable reduction in flow rate occurs.
- RO Membrane Replacement Module: Change it as required based on 90 Percent Rejection. The recommended maximum service life is thirty-six (36) months, at the rated capacity or sooner if a noticeable reduction in flow rate occurs.

How Much Water Should the Tank Hold?

The amount of water the storage tank will hold is determined by the air precharge and the feed water pressure. The RO system will fill the tank until the pressure in the tank reaches two-thirds of the feed water pressure. With an air precharge of 7-8 psi (48-55 kPa), the following chart lists approximate storage capacities when the tank is full:

Feed Water Pressure	Tank Capacity
80 psi (552 kPa)	2.2 gallons (8.3 liters)
60 psi (414 kPa)	2.1 gallons (7.9 liters)
40 psi (276 kPa)	1.5 gallons (5.7 liters)

B. REPLACING THE FILTERS

NOTE: It is essential that the filters be installed in the correct location. Use the icon coded labels to match the filter cartridges with their corresponding filter head.

The life of the filters generally depends on the local water conditions (i.e., sediment, rust and/or chlorine levels) while the life of the post-filter is generally determined by the length of service.

When to Replace the Sediment Replacement Filter

- Every twelve (12) months or sooner depending on local water conditions.
- A noticeable decrease in water production is an indication that the filter requires changing.

When to Replace the Granulated Carbon Replacement Filter

The granulated carbon replacement filter reduces free chlorine in the feed water supply to protect the TFCM membrane from chlorine attack. To find out the chlorine level in a water supply, call the public water supplier.

When to Replace the Carbon Block Replacement Post-Filter

- If the filter is being used to control tastes and odors, replace it every twelve (12) months or sooner depending on local water conditions.

How to Replace the Filters

- 1) Lift up on the faucet handle and close the cold water feed valve. Wait five (5) minutes for the filtration assembly to completely depressurize.

- 2) Remove cover.
- 3) Twist the existing filter 1/4 turn to the left so that the ears on the filter are able to disengage from the head. Firmly pull the filter from the head. It may be necessary to twist the filter slightly from side to side to help free it.
- 4) Remove the new replacement filter from its protective wrap. (Double check to see that it is the correct replacement by comparing the labels.)
- 5) Remove the protective sanitary cap from atop the replacement filter.
- 6) Ensure both o-rings are present on the replacement filter and are seated into grooves; moisten o-rings with water. DO NOT use any petroleum products to lubricate the o-rings.
- 7) Line up the filter ears, insert the filter and push it into the head until it is fully seated. Twist the filter 1/4 turn to the right to lock it into place. (See Fig 7)
- 8) Open the cold water feed valve, and carefully check for leaks.
- 9) RO System Flush Instructions
Sediment & Granulated Carbon Replacement Filters — Close tank. Lift the faucet handle and flush at least two (2) gallons of water through system (approximately 10 minutes).
Carbon Block Post-Filter — Open tank. Lift the faucet handle and flush at least two (2) gallons of water through post-filter (approximately 30 minutes with tank empty or 5 minutes with tank full). It may be necessary to continue flushing until water becomes clear.

IMPORTANT NOTES

- Replacement of filters will result in the need to sanitize the filtration system and/or the storage tank. Please refer to Section D "Sanitizing the RO System" on page 11 for further instructions.

C. REPLACING THE RO MEMBRANE MODULE

The life of the RO membrane module depends on the local water conditions and proper maintenance, e.g., regular module changes. Under typical conditions, the RO membrane module life is thirty-six (36) months or sooner. Unlike the replacement filters, the RO membrane module life is not determined by the amount of water used because of its self-cleaning feature.

How to Replace the RO Membrane Module

- 1) Lift up on the faucet handle and close the cold water feed valve. Wait five (5) minutes for the filtration assembly to completely depressurize.
- 2) Remove cover.
- 3) Make sure that there is some slack in the red SFC tubing connected to the fitting at the bottom of the RO membrane module. Twist the module 1/4 turn to the left (counterclockwise) so that the tubing connection is accessible. (See Fig 7)
- 4) Remove existing red SFC tubing from faucet adapter and membrane module by depressing the small collet and pulling the tubing away from the fittings.

- 5) Firmly pull the module away from the head. (It may be necessary to twist the module slightly from side to side.)
- 6) Remove the new RO membrane module from its protective wrap. (Double check to see that it is the correct replacement by comparing the labels.)
- 7) Remove the sanitary plastic cap atop the module.
- 8) Ensure both o-rings are present on the replacement filter and are seated into grooves; moisten o-rings with water. DO NOT use any petroleum products to lubricate the o-rings.
- 9) Connect the new red SFC reject tubing (supplied with replacement membrane module) by inserting it into the fitting at the bottom of the new RO membrane module as far as it will go, and into the faucet adapter. Line up the module ears, insert the module and push it into the head until it is fully seated. Twist the module 1/4 turn to the right (clockwise) to lock it into place.
- 10) Open the cold water feed valve, and carefully check for leaks. Carefully inspect the fitting at the bottom of the new RO membrane module.
- 11) For sanitization of RO system please follow instructions below in Section D.
- 12) Flush membrane module - refer to Section M, Step 1 and 2 on page 8.

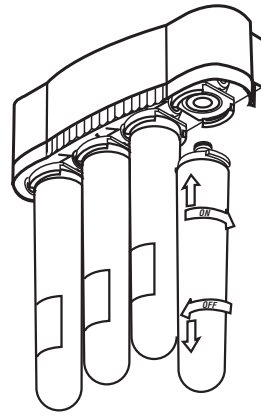

Remove the red SFC tubing from the fitting before completely removing the RO membrane module

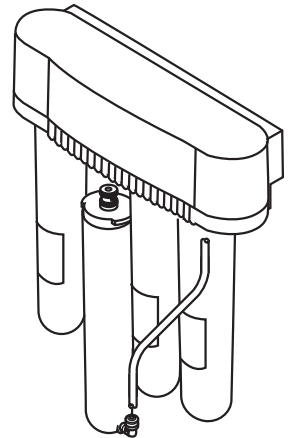

Fig. 7

D. SANITIZING THE RO SYSTEM

Follow the sanitizing procedure for the storage tank and the filtration assembly outlined below, followed by 24 hour flush with tank empty and faucet open.

To help provide you with the highest quality water from your RO Drinking Water Filtration System, it is important to routinely sanitize both the storage tank and the filtration assembly as noted below.

IMPORTANT NOTE: These procedures are only intended to be part of a routine maintenance program only and are not designed to sanitize systems that have become highly contaminated from misuse.

When to Sanitize the Storage Tank

- Upon start-up as described in the beginning of this manual.
- After any servicing or routine maintenance which involves the RO membrane module, carbon block post-filter, storage tank or faucet.

When to Sanitize the Filtration System

- After any servicing or routine maintenance which involves the sediment and granulated carbon replacement filters or the RO membrane replacement module.

How to Sanitize the Storage Tank and Filtration System

Sanitizing the storage tank generally requires:

- Common household bleach (5.25% non-scented)
- Eye dropper or plastic oral syringe

- 1) Close the cold water feed valve and lift up on the faucet handle to empty the water in the storage tank. It should feel light when empty.
- 2) Disconnect the 3/8" yellow tubing (system tank) from the ball valve on top of the storage tank.
- 3) Insert into the yellow tubing 1/2 teaspoon (3 ml) of household bleach. (See Fig 8)
- 4) Reconnect the yellow tube to the tank ball valve.
- 5) Close the RO faucet and open the cold water feed valve.
- 6) Wait 4-5 hours.
- 7) Lift up the handle of the RO faucet and allow contents of tank to drain completely into the sink.
- 8) Sanitizing is now complete.
- 9) If there is any residual chlorine/bleach taste in the next tank full, drain tank completely a second time.

⚠ WARNING

To reduce the risk associated with ingestion of water contaminated with sanitizer:

- After installation, sanitizers **must** be flushed from the system before first use as directed within the installation instructions.

E. LONG TERM NON-USE

If the RO system is to be left unused for a long period of time (greater than 30 days), install new replacement filters.

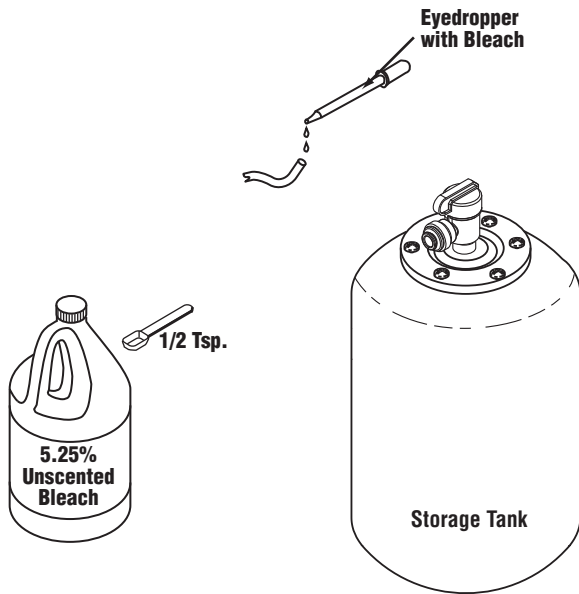

Fig. 8

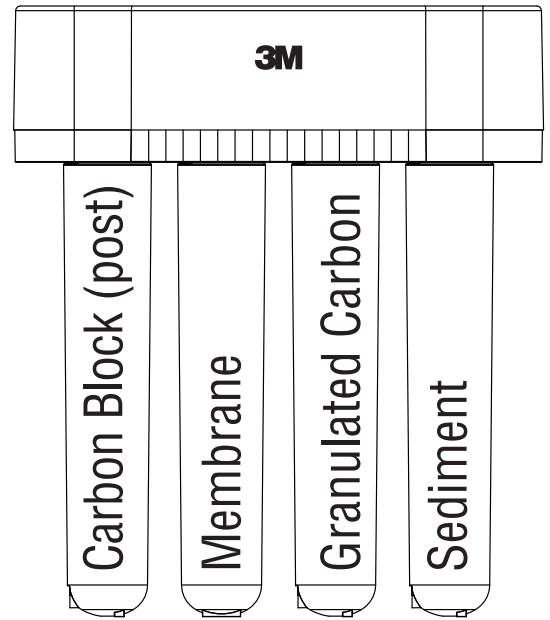

Fig. 9

III. Limited Warranty

Limited Warranty: 3M Purification Inc. warrants this Product will be free from defects in material and manufacture for the following periods from the date of purchase. Twelve (12) year for the Product, except for the replacement filter cartridges and membrane, which are warranted for one (1) year. This warranty does not cover failures resulting from abuse, misuse, alteration or damage not caused by 3M Purification Inc. or failure to follow installation and use instructions. No warranty is given as to the service life of any filter cartridge or membrane as it will vary with local water conditions and water consumption. **3M PURIFICATION INC. MAKES NO OTHER WARRANTIES OR CONDITIONS, EXPRESS OR IMPLIED, INCLUDING, BUT NOT LIMITED TO, ANY IMPLIED WARRANTY OR CONDITION OF MERCHANTABILITY OR FITNESS FOR A PARTICULAR PURPOSE OR ANY IMPLIED WARRANTY OR CONDITION ARISING OUT OF A COURSE OF DEALING, CUSTOMER OR USAGE OF TRADE.** If the Product fails to satisfy this Limited Warranty during the warranty period, 3M Purification Inc. will replace the Product or refund your Product purchase price. This warranty does not cover labor. **The remedy stated in this paragraph is Customer's sole remedy and 3M Purification Inc.'s exclusive obligation.**

This warranty gives you specific legal rights, and you may have other rights which may vary from state to state, or country to country. For any warranty questions, please call 855-3M-WATER (855-369-2837) or mail your request to: Warranty Claims, 3M Purification Inc., 400 Research Parkway, Meriden, CT 06450. Proof of purchase (original sales receipt) must accompany the warranty claim, along with a complete description of the Product, model number and alleged defect.

Limitation of Liability: 3M Purification Inc. will not be liable for any loss or damage arising from this 3M product, whether direct, indirect, special, incidental, or consequential, regardless of the legal theory asserted, including warranty, contract, negligence or strict liability. Some states and countries do not allow the exclusion or limitation of incidental or consequential damages, so the above limitation or exclusion may not apply to you.